

Mini InfraRed Thermometer

With Laser Pointer and High-Low Alarms

Model IRT25

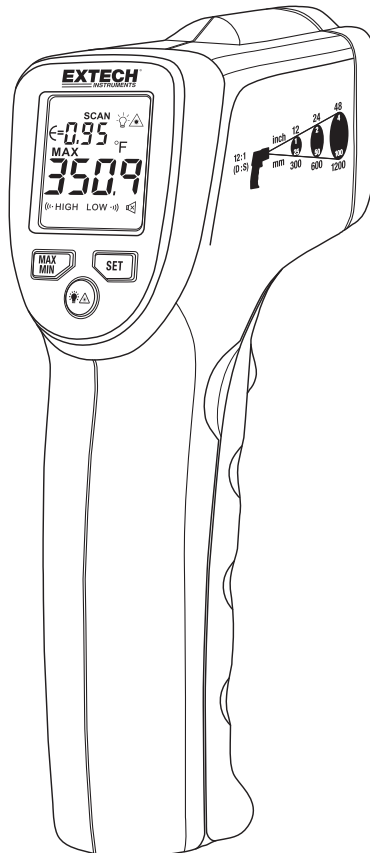

Introduction

Congratulations on your purchase of the IRT25 IR Thermometer. This thermometer makes non-contact (infrared) temperature measurements at the touch of a button. The built-in laser pointer increases target accuracy while the backlit LCD and handy push buttons combine for convenient, ergonomic operation. This device is shipped fully tested and calibrated and, with proper use, will provide years of reliable service. Please visit our website (www.extech.com) to check for the latest version of this User Guide, Product Updates, and Customer Support.

Features

- Measures non-contact surface temperature up to 371°C (400°F)
- 12:1 Distance to Spot Ratio (Field of View)
- Single-point laser targeting
- Automatic Data Hold when trigger is released
- Display Backlight
- Maximum-Minimum temperature function
- Selectable temperature units (°F / °C)
- Dynamic battery status indication
- Adjustable emissivity
- Audible and visible alarm indication for High and Low Temperature Alarm

Safety

International Safety Symbols



This symbol, adjacent to another symbol or terminal, indicates the user must refer to the manual for further information

Warnings

- Do not directly or indirectly point the laser at the eyes of a person or an animal
- Inspect for damage or for any shortage of parts or accessories before use
- Replace the batteries immediately after the battery indicator flashes
- Do not use the thermometer near explosive gases, steam, or dust
- Note that an object with high reflectivity will normally cause the measured temperature value to read much lower than the actual temperature
- Use the device only as described in this User Guide



Cautions

To avoid thermometer damage, please avoid the following hazards:

- EMF from welding equipment or electro-induction heaters
- Static electricity
- Thermal shock caused by large or abrupt environmental temperature changes; wait 30 minutes to allow the thermometer to stabilize to new environmental conditions
- Do not use this device in excessively high temperature environments

Description

Meter Description

1. LCD Display
2. MAX-MIN / Down Button
3. Backlight-Laser Pointer / Up Button
4. Laser pointer lens
5. IR Thermometer lens
6. SET Button
7. Measurement Scan Trigger
8. Battery Compartment

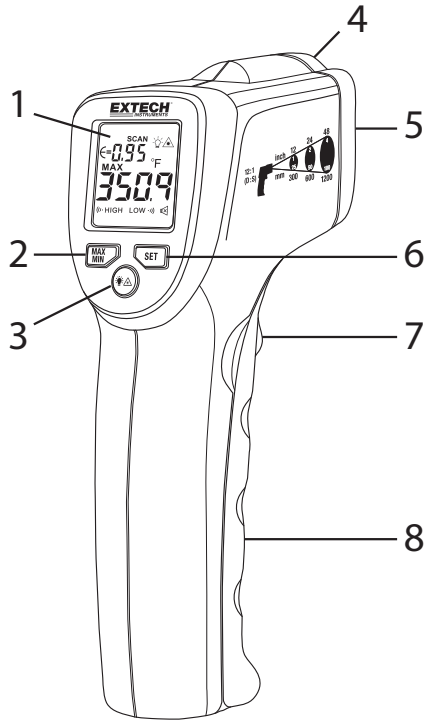

Display Description

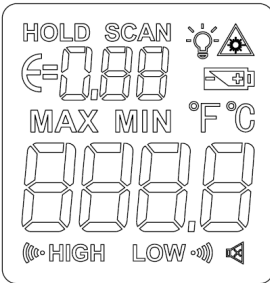

€=	Emissivity value indication
	Laser pointer active icon
SCAN	Scan mode (active while the trigger is pulled; displayed temperature tracks the temperature of the scanned surfaces)
HOLD	Hold mode (displayed temperature freezes with trigger release)
MAX MIN	Maximum/Minimum temperature icons
	Battery capacity indicator (flashes when battery voltage is critical)
	Display Backlight icon
°F °C	Temperature units (°F /°C)
	Temperature Alarm icons and audible alarm disable icon

Operation

Meter Power



The meter is powered by two 1.5V AA batteries. With fresh batteries installed, the meter switches ON when the trigger is pulled. The batteries are located in the meter handle; pull the battery compartment lid away from the body of the meter to open. Refer to the Maintenance section for more Battery Installation instructions. The battery icon provides battery status indication. Replace the batteries as soon as the battery status icon flashes.

Surface Temperature Measurements

1. Hold the meter by its Handle Grip and point it toward the surface to be measured. Read the Field of View section below for distance to target (spot) ratio information.
2. Pull and hold the Trigger to turn the meter on and begin testing in Scan mode. The display will light if the two 1.5V batteries are good. Replace the batteries if the display does not light.
3. Release the Trigger; the reading will hold for approximately 9 seconds, after which the meter will automatically shut off.
4. The meter defaults to the programmed conditions in use when the meter was last switched OFF. For example, if the laser is set to ON and the temperature units are set to °F at the time the unit is switched OFF, the unit will switch ON and use the same settings.

Laser – ON/OFF

Pull the trigger and release.

Push and HOLD the  button for about 3 seconds to switch the laser pointer ON or OFF. The Laser icon will flash when the state has changed. When the laser is ON, the laser icon  will appear on the LCD. Aim the red laser beam approximately a half inch below the point of test (pressing the Laser button again turns the laser off).

MAX-MIN Mode

Press the trigger and release.

Press the MAX-MIN button to view the maximum temperature reading (MAX), press again to view the lowest reading (MIN). Press and hold the MAX-MIN button to switch the MAX-MIN mode off.

Display Backlight

Press the trigger and release.

Press the backlight button  momentarily to switch the backlight ON or OFF.

Over-range Indicators (OL and -OL)

If the temperature measurement exceeds 779°F (415°C), the thermometer will display OL in place of a temperature reading. If the temperature measurement is below -25°C (-13°F), the thermometer will display -OL in place of a temperature reading.



Setting Mode

Release the trigger and press the SET button to access the Setting Mode. Use the SET button to navigate through the Setting Mode fields and use  (UP) and the MAX-MIN (DOWN) buttons to make changes. The available parameters are listed below:

- Emissivity setting
- °C/°F temperature units selection
- Temperature Alarm Audible Beeper Enable/Disable
- High Temperature Alarm Limit setting
- Low Temperature Alarm Limit setting

The corresponding parameter icon will flash when selected. To exit the Setting Mode, press and hold the SET button for two seconds.

Emissivity Setting



The  icon will flash when selected. Use the  up and **MAX-MIN** down buttons to increase or decrease the emissivity (in 0.01 steps). The emissivity range is 0.10 to 1.00. Hold the up or down button to rapidly increase or decrease the emissivity value. Press the SET button to confirm and to step to the next option.

Selecting the Temperature Unit of Measure (°C/°F)

Use the  up and **MAX-MIN** down buttons to select °C or °F. Press the SET button to confirm and to step to the next option.

Enable/Disable Audible Temperature Alarm

This parameter is used to enable/disable the audible temperature alarm. The  icon will flash in this mode.

Use the  up and **MAX-MIN** down buttons to toggle the setting. When the audible alarm is disabled, the display will show 'HIGH LOW'. When the audible alarm is enabled, the display will show  HIGH LOW . When the audible alarm is enabled, the beeper is allowed to sound whenever the measured temperature goes beyond the high or low temperature limit values. Press the SET button to confirm and to step to the next option.

HIGH Temperature Alarm Limit Setting

Use the  up and **MAX-MIN** down buttons to increase or decrease the High Alarm Temperature Limit (in 0.1 steps for °C or 0.2 steps for °F). Holding the up or down button will rapidly increase or decrease the HIGH limit value. A beep will sound if the HIGH temperature value reaches the LOW temperature value while programming. Press the SET button to confirm and to step to the next option.

LOW Temperature Alarm Limit Setting

Use the  up and **MAX-MIN** down buttons to increase or decrease the Low Alarm Temperature Limit (in 0.1 steps for °C or 0.2 steps for °F). Holding down the up or down button will rapidly increase or decrease the LOW limit value. A beep will sound if the LOW temperature value reaches the HIGH temperature value while programming. Press the SET button to confirm and to step to the next option.

Locating Hot or Cold Spots

To detect a hot or cold spot, aim the thermometer at a region beyond the target and then scan the entire region in a slow, up/down motion.

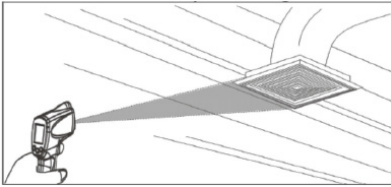

Distance to Spot Ratio (Field of View)

The meter's field of view is 12:1 (distance to spot ratio). For example, if the meter is 24 inches from the target (spot), the diameter of the target must be at least 2 inches. Other distances are shown below in the field of view diagram.

Note that measurements should normally be made closer than 2 feet from the target. The meter can measure from further distances but the measurement may be affected by external sources of light. In addition, the spot size may be so large that it encompasses surface areas not intended to be measured.

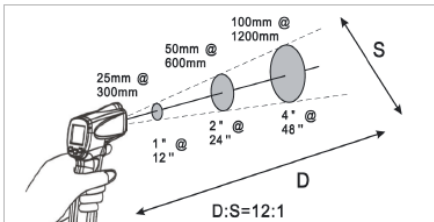

It is necessary to ensure that the size of the target is larger than the spot size. The smaller the target, the closer the distance should be. See the accompanying diagram.

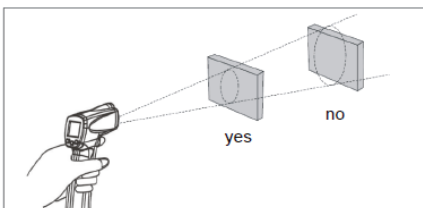

Emissivity

Emissivity represents the energy reflectivity of a material. Most organic materials and painted or oxidized surfaces have an emissivity of approximately 0.95. If possible, masking tape or flat black paint should be applied to cover the measured surface.

Wait a period of time to allow the tape or paint to reach thermal equilibrium with the surface of the covered object. Measure the temperature of the surface covered with tape or paint only after equilibrium has been achieved.

Measurement Notes

1. The object under test should be larger than the spot (target) size calculated by the field of view diagram.
2. If the surface of the object under test is covered with frost, oil, grime, etc., clean before taking measurements.
3. If an object's surface is highly reflective apply masking tape or flat black paint to the surface before measuring.
4. The meter may not make accurate measurements through transparent surfaces such as glass.
5. Steam, dust, smoke, etc. can obscure measurements.
6. The meter compensates for deviations in ambient temperature. It can, however, take up to 30 minutes for the meter to adjust to extremely wide ambient temperature changes.
7. To find a hot spot, aim the meter outside the area of interest then scan across (in an up and down motion) until the hot spot is located.

Maintenance

Cleaning

To clean the lenses use compressed air to clear dust and other particles, then carefully clean with a wet cotton swab. The cotton swab should be moistened with clean water.

To clean the meter housing, wipe with a damp, soft cloth. Do not use solvents or abrasives. Do not immerse the IRT25 in water or other liquid.

Troubleshooting

Symptom	Problem	Action
OL display	Target temperature exceeds range	Select a target within range
-OL display	Target temperature under-range	Select a target within range
Battery icon flashes	Low Battery power	Replace Batteries
Blank display screen	Low battery power	Check and/or replace batteries
No Laser pointer	Low battery or environmental temperature higher than 40°C (104°F)	Replace the batteries or move the IRT25 to an area with a lower ambient temperature

Replacing Batteries

When the battery icon flashes, or when the meter doesn't switch ON, replace the batteries.

The battery compartment is located in the handle grip. The battery compartment lid is located just below the trigger. Pry the compartment lid off to reach the compartment.

Replace the 1.5V AA batteries following correct polarity and then close the battery compartment lid.

Battery Safety Notes: Please dispose of batteries responsibly; never dispose of batteries in a fire, batteries may explode or leak. If the meter is not to be used for 60 days or more, remove the battery and store separately. Do not mix battery types or freshness levels; please use batteries of the same type and of the same freshness level.



Never dispose of used batteries or rechargeable batteries in household waste.

As consumers, users are legally required to take used batteries to appropriate collection sites, the retail store where the batteries were purchased, or wherever batteries are sold.

Disposal: Do not dispose of this instrument in household waste. The user is obligated to take end-of-life devices to a designated collection point for the disposal of electrical and electronic equipment.

Specifications

Infrared Thermometer Specifications

Range / Resolution	-20.0 to 371.0°C (-4.0 to 700.0°F)
Accuracy	-20~0°C (-4~32°F): ±5°C (9°F) 0~371°C (32~700°F) ±2°C (3.6°F) or 2% of reading (whichever is greater) Note: Accuracy is specified for the following ambient temperature range: 21 to 25°C (70 to 77°F)
Emissivity	Adjustable from 0.10 to 1.00
Field of View	12:1 Distance to Spot ratio
Laser power	Less than 1mW, 630 to 670 nm (wavelength)
Spectral response	8 to 14 µm (wavelength)

General Specifications

Display	Backlit LCD display with function indicators
Display rate	500ms approx.
Operating Temperature	0°C to 40°C (32°F to 104°F)
Operating Humidity	Max. 75% RH
Power Supply	Two 1.5V AA Alkaline batteries
Automatic Power Off	Meter shuts off automatically after 9 seconds
Weight	226g (8.0 oz.)
Dimensions	172 x 97 x 46mm (6.8 x 3.8 x 1.8")

Copyright © 2017 FLIR Systems, Inc.

All rights reserved including the right of reproduction in whole or in part in any form

ISO-9001 Certified

www.extech.com